

**Proportional directional valve**

- not pressure compensated
- $Q_{max} = 40$  l/min
- $Q_{Nmax} = 25$  l/min
- $p_{max} = 350$  bar

**DESCRIPTION**

Direct operated proportional spool valve in flange design NG6 acc. to ISO 4401-03/7790 with 4 ports. The spool valve is designed to the 5 chamber principle. The volume flow is adjusted by explosion proof proportional solenoid. Low pressure drop due to the body design and spool profiling. The spool is made of hardend steel. The body made of high grade hydraulic casting for long service life is painted.

**EEx:** in accordance with european standards EN 50014, EN 50018

**d:** flameproof enclosure

**Group II C:** (gas group II A, II B)

for all applications except mining

**Zone 1** (and 2): explosive mixtures present intermittently

**EC-type examination certificate:**

Execution T6: PTB 98 ATEX 1008

**NG6**  
ISO 4401-03

**Ex II 2 G**  
**EEx d II C**

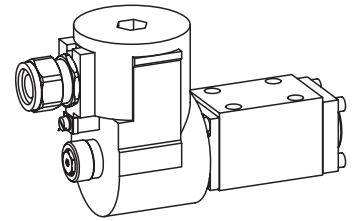
**FUNCTION**

Proportionally to the solenoid current spool stroke, spool opening and valve volume flow will increase. Proportional directional valves NG6 are not load-compensated. The optimum spool shape and progressive characteristics curve allow fine motion control. To control the valve Wandfluh proportional amplifiers are available (see register 1.13).

**APPLICATION**

Proportional directional spool valves are well suited for demanding applications where high resolution, high volume flow and low hysteresis are requested. The facility for remote control and signal processing from process control systems enable elegant, comfortable solutions to problems. These valves are suitable for hazardous areas in off-shore and ship-building applications as well as in chemical, oil and gas industry.

**CONTENT**

GENERAL SPECIFICATIONS.....	1
HYDRAULIC SPECIFICATIONS.....	1
ELECTRICAL SPECIFICATIONS.....	2
TYPE CHARTS/ DESIGNATIONS OF SYMBOLS.....	2
CHARACTERISTICS.....	2/3
DIMENSIONS.....	3
PARTS LIST.....	3
ACCESSORIES.....	3

**TYPE CODE**

		WDB F A06 - <input type="checkbox"/> - <input type="checkbox"/> - <input type="checkbox"/> - G24 / T6 # <input type="checkbox"/>	
Proportional directional valve			
Flange construction			
International standard interface ISO, nominal size 6			
Description of symbols acc. to table 1.10-86/2			
Nominal volume flow $Q_N$ :	5 l/min	<input type="checkbox"/>	5
(at 20 bar pressure drop)	10 l/min	<input type="checkbox"/>	10
	16 l/min	<input type="checkbox"/>	16
	25 l/min	<input type="checkbox"/>	25
Standard nominal voltage $U_N$ :		24 VDC	
Execution:		T1...T6	
Design-Index (Subject to change)			

**GENERAL SPECIFICATIONS**

Nominal size	NG6 acc. to ISO 4401-03/7790	
Designation	4/2-, 4/3-way proportional directional valve	
Construction	Direct operated spool valve	
Mounting	Flange, 4 fixing holes for socket head cap screws M5x50	
Fastening torque	$M_D = 5,5$ Nm (screw qual. 8.8)	
Pipe connection	Connection plates Multi-station flange subplate Longitudinal stacking system	
Mounting position	any, preferably horizontal	
Admissible ambient temp. *:		
Execution T6	-20...+90 °C (operation as T1...T4) -20...+40 °C (operation as T5/T6)	
Weight:	4/2-way	m = 2,8 kg
	4/3-way	m = 4,8 kg

**HYDRAULIC SPECIFICATIONS**

Fluid	Mineral oil, other fluid on request
Contamination	ISO 4406:1999, class 18/16/13
efficiency	(Required filtration grade $\beta_{6...10} \geq 75$ ) refer to data sheet 1.0-50/2
Viscosity range	12 mm <sup>2</sup> /s...320 mm <sup>2</sup> /s
Admissible fluid temp.*:	
Execution T6	-20...+70 °C (operation as T1...T4) -20...+40 °C (operation as T5/T6)
Working pressure	$p_{max} = 350$ bar (connections P, A, B)
Tank pressure	$p_{max} = 160$ bar (connection T)
Nominal volume flow	$Q_N = 5$ l/min, 10 l/min, 16 l/min, 25 l/min
Max. volume flow	see characteristic
Leakage volume flow	on request
Hysteresis	$\leq 5$ % ** ** at optimal dither signal

\* Deviating pressure medium - or ambient temperatures are possible for special arrangements after checking and authorisation by a responsible inspector. Measures for the prevention of the exceeding of the admissible solenoid surface - and internal temperatures can be: a good ventilation, low ambient temperatures (for higher pressure medium temperatures), limitation of the maximum possible power supply voltage, a short switching-on duration, installation on large heat dissipating blocks, etc. The responsibility in all cases lies with the operator, resp. with his inspector.

**ELECTRICAL SPECIFICATIONS**

Construction	Proportional solenoid, wet pin push type, pressure tight
Standard nominal voltage	$U_N = 24$ VDC wired with VDR
Limiting current	T6: $I_G = 260$ mA
Relative duty factor	100% ED
Protection class	IP 65 acc. to EN 60 529
Connection/Power supply	Through cable entry for cable $\varnothing$ 11...14 mm (acc. to EN 50014)
Temperature class	T1...T6
Execution T6	6 W at $I_G = 260$ mA

**START-UP**

Information concerning the installation and commissioning is contained in the operating instructions supplied together with the solenoid coil.

**TYPE CHARTS / DESIGNATIONS OF SYMBOLS**

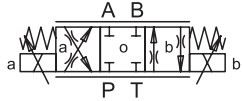
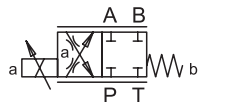
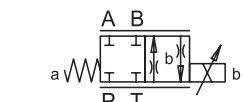
	<b>ACB - S</b> S = Symmetrical control mode
	<b>AC1 - S</b> S = Symmetrical control mode
	<b>CB2 - S</b> S = Symmetrical control mode

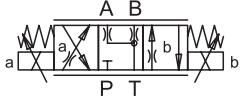
	<b>ADB - V</b> V = Meter-in control mode
--	---

**CHARACTERISTICS** oil viscosity  $\nu = 30$  mm<sup>2</sup>/s

$Q = f(p)$  Volume flow pressure characteristics ( $i = I_G$ )  
[Types: ACB-S, AC1-S, CB2-S]

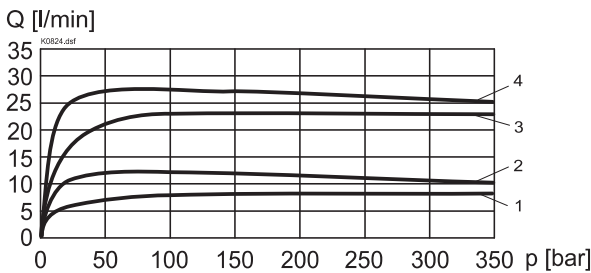

$Q = f(p)$  Volume flow pressure characteristics ( $i = I_G$ )  
[Type: ADB-V]

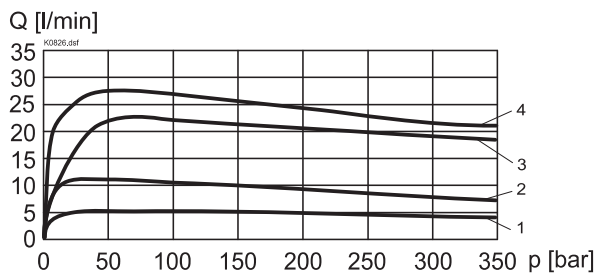

$\Delta p = f(Q)$  Pressure loss/flow characteristics ( $i = I_G$ )  
[Types: ACB-S, AC1-S, CB2-S]

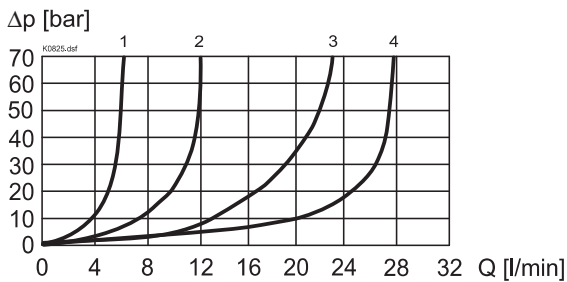

$\Delta p = f(Q)$  Pressure loss/flow characteristics ( $i = I_G$ )  
[Type: ADB-V]

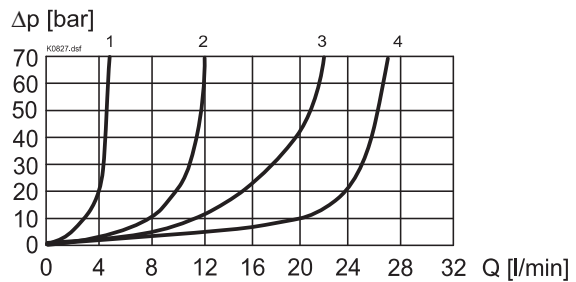

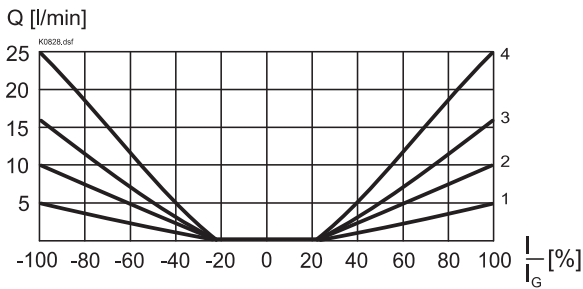
Q = f (l) Volume flow adjustment characteristics ( $\Delta p = 20 \text{ bar}$ )  
 [Types: ACB-S, AC1-S, CB2-S]

**Legend:**

- 1:  $Q_N = 5 \text{ l/min}$       3:  $Q_N = 16 \text{ l/min}$   
 2:  $Q_N = 10 \text{ l/min}$     4:  $Q_N = 25 \text{ l/min}$

**DIMENSIONS**

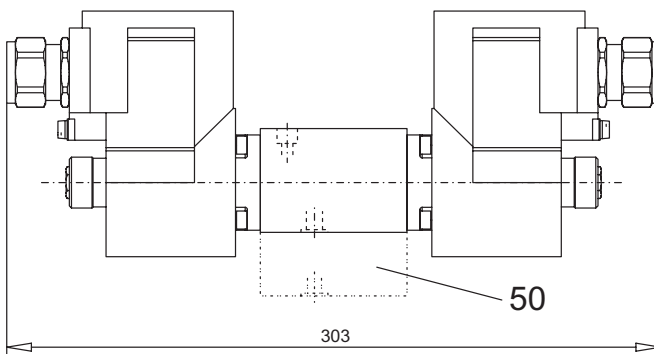
4/3-way valve

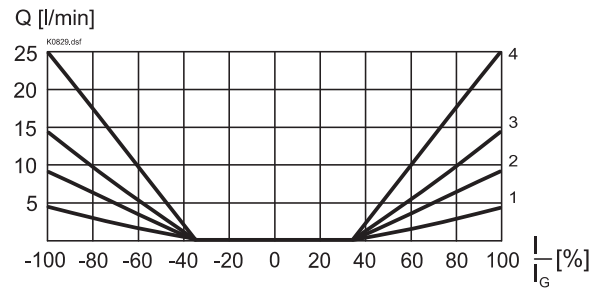

Order distance plate ADP6/30 separately

 Q = f (l) Volume flow adjustment characteristics ( $\Delta p = 20 \text{ bar}$ )  
 [Type: ADB-V]

**NOTE!**

 All values measured over 2 metering edges,  
 A and B ports linked

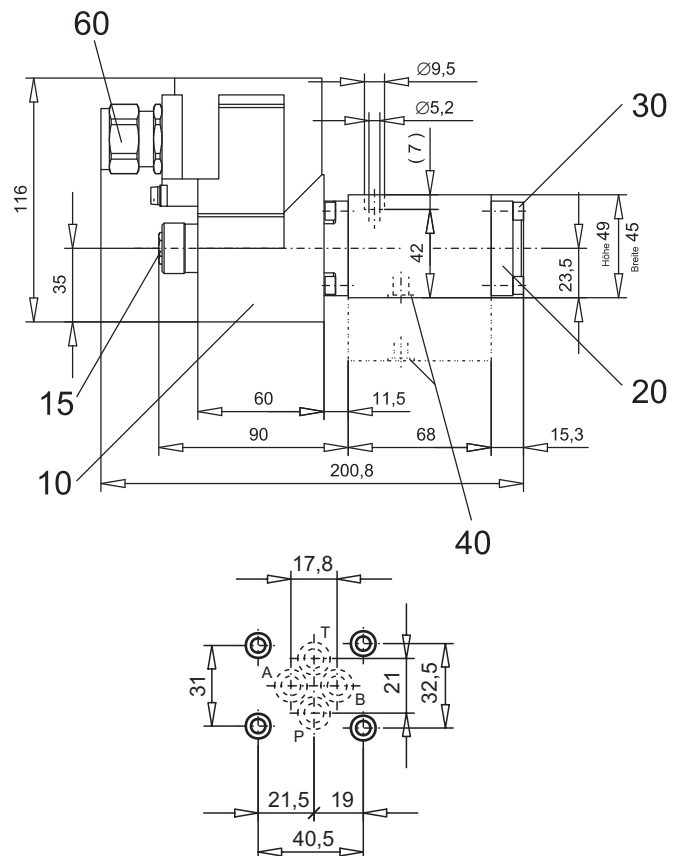
4/2-way valve

**PARTS LIST**

Position	Article	Description
10	207.5...	Coil type EExd
15	253.8001	Plug with integrated manual override HB6
20	058.4211	Cover
30	246.2117	Socket head cap screw M5x16 DIN 912
40	160.2093	O-Ring ID 9,25x1,78
50	173.3453	Distance plate ADP6/30
60	111.1080	Cable entry brass M20

**ACCESSORIES**

 Sub-plates  
 Proportional-amplifier

 Register 2.9  
 Register 1.13

Technical explanation see data sheet 1.0-100E